

# Bi-Spectral PTZ Network Camera User Manual



**Issue**

**V1.0**

**Date**

**2019-11-27**







# Precautions

## Precautions

Fully understand this document before using this device, and strictly observe rules in this document when using this device. If you install this device in public places, provide the tip "You have entered the area of electronic surveillance" in an eye-catching place. Failure to correctly use electrical products may cause fire and severe injuries. To prevent accidents, carefully read the following context:

## Symbols

This document may contain the following symbols whose meanings are described accordingly.

Symbol	Description
 <b>DANGER</b>	It alerts you to fatal dangers which, if not avoided, may cause deaths or severe injuries.
 <b>WARNING</b>	It alerts you to moderate dangers which, if not avoided, may cause minor or moderate injuries.
 <b>CAUTION</b>	It alerts you to risks. Neglect of these risks may cause device damage, data loss, device performance deterioration, or unpredictable results.
 <b>TIP</b>	It provides a tip that may help you resolve problems or save time.
 <b>NOTE</b>	It provides additional information.



### **DANGER**

To prevent electric shocks or other dangers, keep power plugs dry and clean.



### **WARNING**

- Strictly observe installation requirements when installing the device. The manufacturer shall not be held responsible for device damage caused by users' non-conformance to these requirements.

- Strictly conform to local electrical safety standards and use power adapters that are marked with the LPS standard when installing and using this device. Otherwise, this device may be damaged.
- Use accessories delivered with this device. The voltage must meet input voltage requirements for this device.
- If this device is installed in places with unsteady voltage, ground this device to discharge high energy such as electrical surges in order to prevent the power supply from burning out.
- When this device is in use, ensure that no water or any liquid flows into the device. If water or liquid unexpectedly flows into the device, immediately power off the device and disconnect all cables (such as power cables and network cables) from this device.
- Do not expose the thermal imaging camera or unpacked product to extremely strong radiation sources, such as the sun, laser, or arc welding machine, regardless of whether the device is being electrified or not; do not put the camera close to high thermal objects such as the sunlight; otherwise, the precision of the camera may be affected and even the detector inside the camera may suffer a permanent damage.
- If this device is installed in places where thunder and lightning frequently occur, ground the device nearby to discharge high energy such as thunder strikes in order to prevent device damage.

**CAUTION**

- Unless otherwise specified, do not use the camera in a temperature lower than -10 °C (+14 °F) or higher than +50 °C (+122 °F). Too-high or too-low temperature may cause image display anomaly of the camera and the camera will be damaged if it is working under such a condition for a long time.
- If the camera is installed outdoors, avoid direct sunlight at dawn and dusk on the camera lens and install a sunshield with frontal and rear positions adjusted according to the sunlight angle.
- Avoid heavy loads, intensive shakes, and soaking to prevent damages during transportation and storage. The warranty does not cover any device damage that is caused during secondary packaging and transportation after the original packaging is taken apart.
- Protect this device from fall-down and intensive strikes, keep the device away from magnetic field interference, and do not install the device in places with shaking surfaces or under shocks.
- Clean the device with a soft dry cloth. For stubborn dirt, dip the cloth into slight neutral cleanser, gently wipe the dirt with the cloth, and then dry the device.
- Since the camera lens is painted with a durable coating material, it adapts to outdoor environment. The lens must be cleaned regularly. If the image quality is reduced or excessive dirt is deposited on the lens, clean the lens in a timely manner. In sandy (in desert) or corrosive (on sea) environment, use the camera with caution; improper use may cause the coating to peel off.

- Do not jam the ventilation opening. Follow the installation instructions provided in this document when installing the device.
- Keep the device away from heat sources such as radiators, electric heaters, or other heat equipment.
- Keep the device away from moist, dusty, extremely hot or cold places, or places with strong electric radiation.
- If the device is installed outdoors, take insect- and moisture-proof measures to avoid circuit board corrosion that can affect monitoring.
- Remove the power plug if the device is idle for a long time.
- Before unpacking, check whether the fragile sticker is damaged. If the fragile sticker is damaged, contact customer services or sales personnel. The manufacturer shall not be held responsible for any artificial damage of the fragile sticker.

## Special Announcement

All complete products sold by the manufacturer are delivered along with nameplates, operation instructions, and accessories after strict inspection. The manufacturer shall not be held responsible for counterfeit products.

This manual may contain misprints, technology information that is not accurate enough, or product function and operation description that is slightly inconsistent with the actual product. The manufacturer will update this manual according to product function enhancement or changes and regularly update the software and hardware described in this manual. Update information will be added to new versions of this manual without prior notice.

This manual is only for reference and does not ensure that the information is totally consistent with the actual product. For consistency, see the actual product.

# Contents

**Precautions** ..... **i**

**1 Overview** ..... **6**

    1.1 Principle of Thermal Imaging and Advantages ..... 6

    1.2 Product Introduction ..... 6

        1.2.1 Function ..... 7

        1.2.2 Product Features ..... 7

    1.3 Description of PTZ cable ..... 8

        1.3.1 Aviation Power Supply and Network Cable of Twenty-six cores ..... 8

        1.3.2 Aviation Alarm Cable of Twenty-six Cores ..... 9

**2 Device Dimensions** ..... **12**

**3 Device Installation**..... **13**

    3.1 Installation Method ..... 13

    3.2 Device Installation..... 13

        3.2.1 Installation of Basic Requirements..... 13

        3.2.2 Basic Installation Tool..... 13

        3.2.3 Installation Space and Installation Strength ..... 14

        3.2.4 Definition of Installation Wiring Harness ..... 14

**4 Quick Configuration** ..... **16**

    4.1 Thermal Web ..... 16

        4.1.1 Login and Logout ..... 16

        4.1.2 Main Page Layout ..... 17

        4.1.3 Change the Password ..... 18

        4.1.4 Browse Video..... 19

        4.1.5 Install Plugins..... 21

        4.1.6 Set Local Network Parameters ..... 21

        4.1.7 Thermal Settings ..... 24

            4.1.7.1 Temperature Parameters ..... 24

            4.1.7.2 Temperature Area ..... 28

            4.1.7.3 Schedule Linkage ..... 32

            4.1.7.4 Bad Point Check..... 34

---

<b>5 Thermal Parameter Configuration.....</b>	<b>36</b>
5.1 Access the Sensor Setting Interface.....	36
5.2 Sensor Setting Parameter.....	37
5.2.1 Time Segment .....	37
5.2.2 Image Setting .....	37
5.2.3 Scene.....	39
5.2.4 Set Pseudocolor.....	39
5.2.5 FFC Control .....	40
5.2.6 Noise Reduction.....	42
5.2.7 Enhance Image.....	43
<b>6 PTZ Function Application.....</b>	<b>45</b>
6.1 PTZ Control function .....	45
6.2 PTZ configuration .....	46
6.2.1 PTZ Setting .....	46
6.2.2 Configure and Apply Preset .....	46
6.2.3 Configure and Apply Tracks .....	47
6.2.4 Configure and Apply Scan .....	48
6.2.5 Configure and Apply Tour.....	49
6.2.6 Configure and Apply Idle .....	50
6.2.7 Configure Timer .....	51
6.2.8 Configure Extension.....	53
<b>7 Technical Specifications.....</b>	<b>54</b>
<b>A Troubleshooting.....</b>	<b>58</b>
<b>B Common Emission Rate.....</b>	<b>61</b>

# 1 Overview

## 1.1 Principle of Thermal Imaging and Advantages

Any object with temperature higher than the absolute zero ( $-273.15^{\circ}$  F) will emit infrared (IR) ray, even though it does not emit light. The IR ray is also called thermal radiation. IR rays emitted by objects with different temperatures can be absorbed by the detector to reflect temperature change and thus generate an electric effect. The electric signal is amplified and processed to produce a thermal image that corresponds to the thermal distribution of the object surface. This is the process of thermal imaging.

- Adapt to any environment

Traditional cameras rely on natural or environmental light to shoot images, but this IR thermal imaging camera relies on the IR energy radiated by an object itself to form an image, not requiring any light. The IR thermal imaging camera is applicable to any environment and not affected by light strength. It can detect and identify any camouflage and concealed object both in daytime or nighttime, implementing round-the-clock monitoring.

- Monitor the temperature field with object energy distributed

The IR thermal imaging camera can show the temperature field of an object, converting the invisible surface temperature distribution situation to a visible thermal image that reflects the surface temperature distribution situation of the object. By this monitoring, users can discover temperature anomaly in a timely manner and take precautionary measures to avoid any risk that may be caused by the anomaly, for example, a fire.

- Boast cloud penetration capability

Visible light and near IR ray will be absorbed by the air, cloud and smoke, but they are transparent to IR ray of the 3~5  $\mu\text{m}$  Medium Wavelength Infrared (MWIR) region and 8~14  $\mu\text{m}$  Long Wavelength Infrared (LWIR) region. Traditional cameras cannot shoot clear images under cloudy environment, but the IR thermal imaging camera can penetrate the cloud and smoke to shoot clear images.

## 1.2 Product Introduction

Bi-Spectral PTZ Network Camera the whole machine shell and the base are all made of high strength aluminum alloy material with comprehensive function and high stability. Can adapt to a variety of bad environment, heavy load can reach more than 50 kg and run smoothly. This series has  $360^{\circ}$  continuous rotation,



automatic scanning, automatic cruise and other functions, suitable for large areas of monitoring, can be widely used in airports, stations, urban roads, traffic survey and monitoring, forest fire prevention, the high and heavy equipment rotary control and other important area.

## 1.2.1 Function

- To support a variety of scanning methods, such as cruise scan, pattern scanning, etc.
- It supports the function of power off memory and automatically returns to the monitoring scene before power off.
- Support network signal and analog signal double output, cloud platform control classification operation.
- The double helix structure of worm gear and worm drive, the electronic image stabilization, and mechanical locking design, power self-locking function.
- Horizontal continuous rotation 360 °, vertically +45 °~- 45 °rotating, horizontal velocity is 0.01 ~60 %S, vertical speed of 0.01 °~ 15 %S.
- Support proportion variable times function, rotation speed adjusted automatically according to the lens change multiple times.
- Support watch features preset point/figure/cruise can stay idle scan specified Automatic call after time (including the idle state entered after power).

## 1.2.2 Product Features

- Outdoor intelligent variable speed PTZ, the fuselage selection of high strength aluminum alloy material, exterior design can resist strong winds, smooth operation, high precision.
- Products using high-precision stepper motor and precision worm gear drive combination, power can be self-locking.
- Support a variety of lens preset function, zoom adaptive function, the rotation speed can be automatically adjusted according to the lens zoom factor.
- Powerful, with preset, cruise, line sweep, keep watch and other functions.
- Visual pitch angle range, monitoring a wide range of horizontal speed up to 10° / s.
- Equipment has its own automatic heating system, low temperature automatically start heating function, to ensure that products can be applied to cold areas.
- Network transmission signal can reach 100 Mbps.
- Device supports RS485 / RS422 communication interface, you can remotely upgrade the device program, easy to maintain.
- Power failure memory function, accidental power after re-power, the memory of the last running state, can be restored to power before running state.

## 1.3 Description of PTZ cable

### 1.3.1 Aviation Power Supply and Network Cable of Twenty-six Cores

Aviation power supply and network cable of twenty-six cores is shown as Figure 1-1 & Figure 1-2, and the description is shown in Table 1-1.

Figure 1-1 Aviation power supply and network cable of twenty-six cores



Figure 1-2 Definition of twenty-six cores

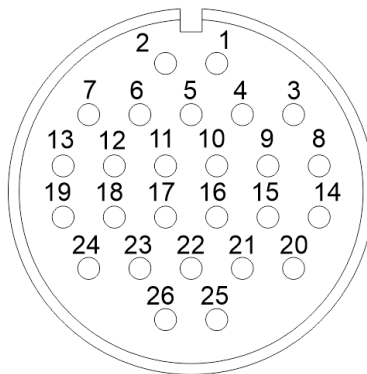

Table 1-1 Description of twenty-six cores

SN	Name	Description
1	DC24V -	Black (Thick)
2	DC24V +	Red (Thick)
3	DC24V -	Black (Thick)
4	DC24V -	Black (Thick)
5	Alarm_OUT1	Red (Thin)
6	DC24V +	Red (Thick)
7	DC24V +	Red (Thick)
8	Audio_IN(G)	Audio masking
9	Audio_IN	Audio Core
10	Alarm_OUT1	Black (Thin)
11	Alarm_OUT3	Blue
12	Alarm_OUT3	Pink
13	Alarm_OUT4	White
14	Audio_OUT(G)	Audio masking
15	Audio_OUT	Audio Core
16	Video	Video Core
17	Video (G )	Video masking
18	Alarm_OUT2	White and Orange
19	Alarm_OUT4	Green
20	RS485A	Orange (Thick)
21	RS485B	Yellow (Thick)
22	ETHTX+	White and Orange
23	ETHTX-	Orange
24	Alarm_OUT2	White and Yellow
25	ETHRX+	White and Green
26	ETHRX-	Green

### 1.3.2 Aviation Alarm Cable of Twenty-six Cores

Aviation alarm cable of twenty-six cores is shown as Figure 1-3& Figure 1-4, and the description is shown in Table 1-2.

Figure 1-3 Aviation power supply cable of twenty-six cores



Figure 1-4 Definition of twenty-six cores

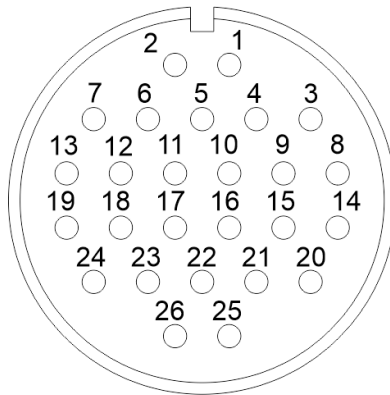

Table 1-2 Description of twelve cores

SN	Name	Description
1	Reserved core	Blank

SN	Name	Description
2	Reserved core	Blank
3	Reserved core	Blank
4	Reserved core	Blank
5	Reserved core	Ground
6	Reserved core	Blank
7	Reserved core	Blank
8	Reserved core	Ground
9	Reserved core	Ground
10	Reserved core	Blank
11	Alarm_IN1	White
12	Alarm_IN2	White and Orange
13	Alarm_IN3	Blue
14	Audio_IN(G)	Audio masking
15	Audio_IN	Audio Core
16	Video	Video Core
17	Video (G)	Video masking
18	Audio_OUT	Audio Core
19	Audio_OUT(G)	Audio masking
20	Alarm_IN4	Pink
21	Alarm_IN5	Red (Thin)
22	Alarm_IN6	White and Yellow
23	Alarm_IN7	Blank
24	Alarm_IN8	Yellow (Thick)
25	Alarm_IN9	Orange (Thick)
26	Alarm_G	Black (Thick)

----End

# 2 Device Dimensions

Figure 2-1 shows the dimensions of the Bi-Spectral PTZ Network Camera.

Figure 2-1 Dimensions (unit: mm)

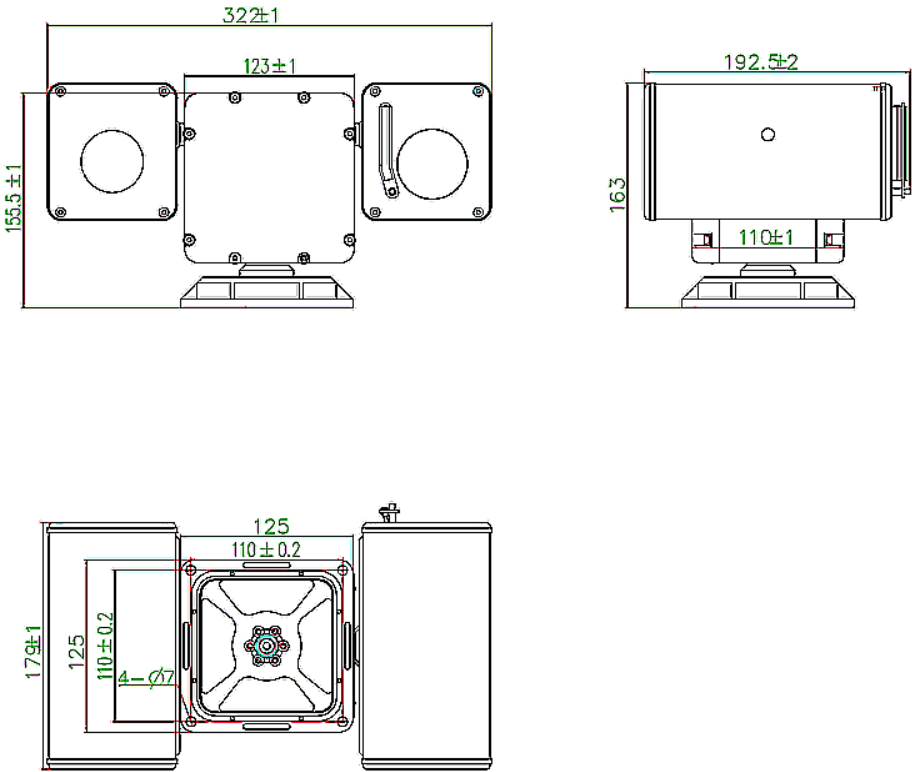

# 3 Device Installation

## 3.1 Installation Method

Bi-Spectral PTZ Network Camera can be installed on camera base. Figure 3-1 shows the base dimensions of PTZ camera.

Figure 3-1 Base dimensions of PTZ camera (unit: mm)

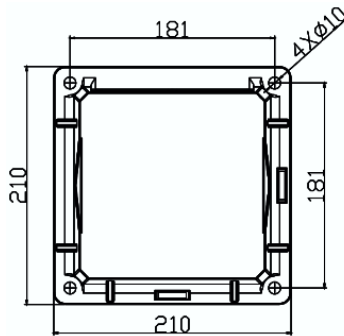

## 3.2 Device Installation

### 3.2.1 Installation of Basic Requirements

Installation site and environment to meet the technical parameters mentioned in the requirements, the installation staff should have been fully read and read the contents of this manual, with the appropriate system installation qualification and maintenance work qualification certificate.

### 3.2.2 Basic Installation Tool

Commonly used engineering wiring and equipment installation tools, please install the equipment before the preparation is complete.

Table 3-1 shows the installation tools list.

Table 3-1 Installation tools

Name	Quantity	Remarks
13mm wrench	1	For mounting fixtures and mounting brackets
14mm sleeve	1	
Cross screwdriver(big)	1	For common construction
Cross screwdriver(small)	1	Used to disassemble the DIP cover to adjust the device communication parameters
Inside the hex wrench	1 set	Used for disassembly of pan / tilt pallet and shield connection
Word screwdriver (small)	1	to secure the wiring harness connection terminals
Wire strippers	1	Stripping

### 3.2.3 Installation Space and Installation Strength

Under normal circumstances, this device needs to be equipped with a protective cover or other overhead items, please confirm the installation location can accommodate this product and the equipment and installation of the structure of the space. To confirm the installation of the wall, the carrying capacity of the bracket can reach 4 times the safety of the entire equipment weight.

### 3.2.4 Definition of Installation Wiring Harness

The bottom line includes power line, network cable, RS422, geodetic line, video line, and according to the demand, there are various types of outgoing line. The details need to be controlled according to the line signature of each device.

Table 3-2 shows Definition of installation wiring harness.

Table 3-2 Definition of installation wiring harness

COLOR	Function define	Remark
BNC	Video	Optional
Red	DC24V+	
Black	DC24V-	
RJ45	Network cable	
Orange	RS422 TX+	
Yellow	RS422 TX-	
Red	RS422 RX+	
Blue	RS422 RX-	



COLOR	Function define	Remark
Yellow & Green	GND	

 **NOTE**

In order to prevent lightning strikes, the grounding wire (yellow-green wire) in the cable outlet base must be grounded reliably and the grounding resistance should be  $<4\Omega$ .

**----End**

# 4 Quick Configuration

## 4.1 Thermal Web

### 4.1.1 Login and Logout



#### CAUTION

You must use Internet Explorer 8 or a later version to access the web management system; otherwise, some functions may be unavailable.

#### Login system

Step 1 Open the Internet Explorer, enter the IP address of IP camera (default value: 192.168.0.121) in the address box, and press Enter.

The login page is displayed, as shown in Figure 4-1.

Figure 4-1 Login page

The screenshot shows the login interface for an IP camera. It features a light blue header with the text 'IP CAMERA' in a large, bold, blue font. To the right of the header, there is a language selection dropdown menu currently set to 'English'. Below the header, there are two text input fields: one for 'User Name' and one for 'Password'. To the right of these input fields is a blue button labeled 'Login'.

Step 2 Input the User name and password.

#### NOTE

- The default user name is **admin**. The default password is **admin**. Change the password when you log in the system for first time to ensure system security.
- You can change the system display language on the login page.

Step 3 Click Login.

The main page is displayed.

----End

## logout

To logout of system, click  in the upper right corner of the main page, the login page is display after you log out of the system.

## 4.1.2 Main Page Layout



On the main page, you can view real-time video, set parameter, Video parameter, Video control, PTZ control, PTZ Configure and log out of the system. Figure 4-2 is shown the main page layout. Table 4-1 lists the elements on the main page layout.

Figure 4-2 Main page layout







Table 4-1 Elements on the main page

No.	Element	Description
1	Real-time video area	Real-time videos are played in this area. You can also set sensor parameters.
2	Playback	You can query the playback videos in this area. NOTE Only when the SD card or NAS have videos that user can query

No.	Element	Description
		the playback videos.
3	Device configuration	You can choose a menu to set device parameters, including the device information, audio and video streams, alarm setting, and privacy mask function.
4	Change password	You can click  to change the password.
5	Sign Out	You can click  to return to the login page.
6	Stream	There are three streams. Choose one type from drop-down list.
7	PTZ	Click to enter the PTZ interface.
8	Pause/Start	Close live video or play live video.
9	Live/Smooth	Switch image quality.
10	Audio	Open or close audio.
11	Interphone	Open or close interphone.
12	Sensor setting	Click the icon, it will access to sensor setting.
13	Snapshot	Click the icon, it will snapshot.
14	Local record	Click the icon, it will record video and save.
15	Intelligent analysis	Open the intelligent, choose the stream to stream 2, click to open the intelligent analysis, it will show target information and video stream draw line after you have turned on the function in IVS settings.

 **NOTE**

1. When the device generates an alarm, the alarm icon  is displayed. You can click  to view the alarm information. When the device accepts an alarm signal, the alarm icon will display within 10s in the web management system.
2. When the device encounters an exception, the fault icon  is displayed. You can click  to view the fault information.

----End

### 4.1.3 Change the Password

#### Description

You can click  to change the password for logging in to the system.

Procedure

Step 1 Click  in the upper right corner of the main page.

The **Change Password** dialog box is displayed, as shown in Figure 4-3.

Figure 4-3 Modify Password dialog box

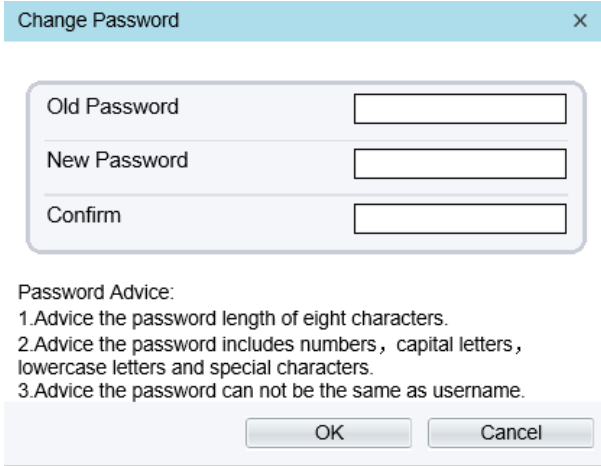

Change Password X

Old Password

New Password

Confirm

Password Advice:  
1. Advice the password length of eight characters.  
2. Advice the password includes numbers, capital letters, lowercase letters and special characters.  
3. Advice the password can not be the same as username.

OK Cancel

 **NOTE**

The change password page will be displayed if you don't change the default password when you login the system for the first time.

Step 2 Enter the old password, new password, and confirmation password.

Step 3 Click **OK**.

If the message "Change own password success" is displayed, the password is successfully changed. If the password fails to be changed, the cause is displayed. (For example, the new password length couldn't be less than eight.)

Step 4 Click **OK**.

The login page is displayed.

**----End**

## 4.1.4 Browse Video

User can browse the real-time video in the web management system.

### Preparation

To ensure the real-time video can be play properly, you must perform the following operation when you log in to the web for the first time:

Step 1 Open the Internet Explorer. Choose **Tools > Internet options > Security > Trusted sites > Sites**.

In the display dialog box, click **Add**, as shown in Figure 4-4.

Figure 4-4 Adding the a trusted site

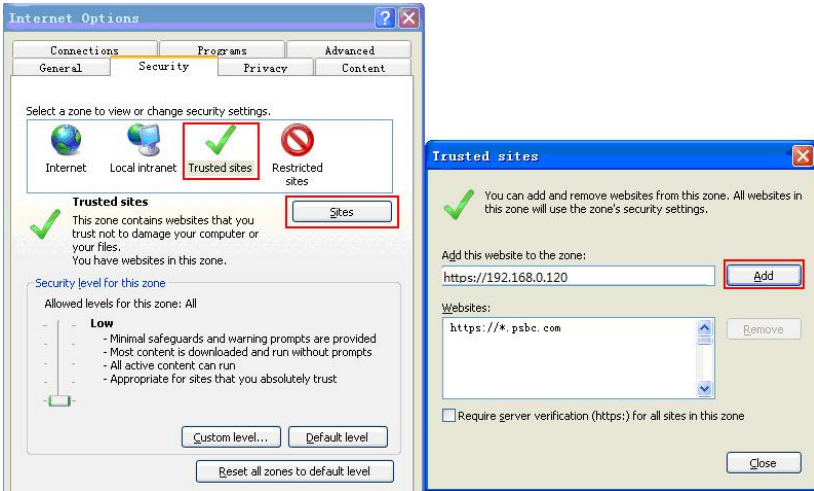

Step 2 In the Internet Explorer, choose **Tool > Internet Options > Security > Customer level**, and set Download unsigned ActiveX control and initialize and script ActiveX controls not marked as safe for scripting under ActiveX controls and plug-ins to Enable, as shown in Figure 4-5.

Figure 4-5 Configuring ActiveX control and plug-ins

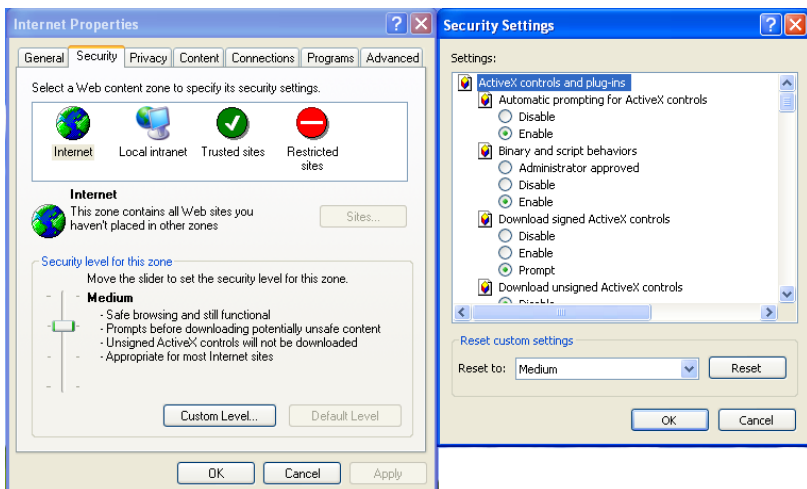

Step 3 Download and install the player control as prompted.

 **NOTE**

The login page is display when the control is loaded.

### 4.1.5 Install Plugins

You will be prompted with a message “Download and install the new plugin” as shown in Figure 4-6 when you log in to the web management system for the first time.

Figure 4-6 Download the plugin page

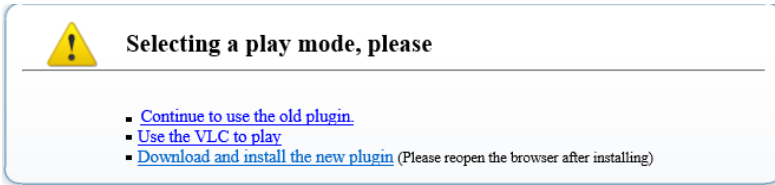

#### Procedure

Step 1 Click the message, download and install the plugin follow the prompts.

Step 2 Reopen the browser after installation.

----End

### 4.1.6 Set Local Network Parameters

#### Description

Local network parameters include:

- IP protocol
- IP address
- Subnet mask
- Default gateway
- Dynamic Host Configuration Protocol (DHCP)
- Preferred Domain Name System (DNS) server
- Alternate DNS server
- MTU

#### Procedure

Step 1 Choose **Configuration > Device >Local Network**.

The **Local Network** page is displayed, as shown in Figure 4-7.

Figure 4-7 Local Network page

 **Local Network**

---

IP Protocol IPv4 ▼

---

DHCP  OFF

IP Address

Subnet Mask

Default Gateway

---

Preferred DNS Server

Alternate DNS Server

MTU(800-1500)

---

Step 2 Set the parameters according to Table 4-2.

Table 4-2 Local network parameters

Parameter	Description	Setting
IP Protocol	IPv4 is the IP protocol that uses an address length of 32 bits.	[Setting method] Select a value from the drop-down list box. [Default value] <b>IPv4</b>
DHCP	The device automatically obtains the IP address from the DHCP server.	[Setting method] Click the option button. NOTE To query the current IP address of the device, you must query it on the platform based on the device name.
DHCP IP	IP address that the DHCP server assigned to the device.	N/A
IP Address	Device IP address that can be set as required.	[Setting method] Enter a value manually. [Default value] <b>192.168.0.120</b>



Parameter	Description	Setting
Subnet Mask	Subnet mask of the network adapter.	[Setting method] Enter a value manually. [Default value] <b>255.255.255.0</b>
Default Gateway	This parameter must be set if the client accesses the device through a gateway.	[Setting method] Enter a value manually. [Default value] <b>192.168.0.1</b>
Preferred DNS Server	IP address of a DNS server.	[Setting method] Enter a value manually. [Default value] <b>192.168.0.1</b>
Alternate DNS Server	IP address of a domain server. If the preferred DNS server is faulty, the device uses the alternate DNS server to resolve domain names.	[Setting method] Enter a value manually. [Default value] <b>192.168.0.2</b>
MTU	Set the maximum value of network transmission data packets.	[Setting method] Enter a value manually.  NOTE The MTU value is range from 800 to 1500, the default value is 1500, Please do not change it arbitrarily.

Step 3 Click **OK**.

- If the message "Apply success" is displayed, click OK. The system saves the settings. The message "Set network param's success, Please login system again" is displayed. Use the new IP address to log in to the web management system.
- If the message "Invalid IP Address", "Invalid Subnet Mask", "Invalid default gateway", "Invalid primary DNS", or "Invalid space DNS" is displayed, set the parameters correctly.

 **NOTE**

- If you set only the **Subnet Mask**, **Default Gateway**, **Preferred DNS Server**, and **Alternate DNS Server** parameters, you do not need to log in to the system again.
- You can click **Reset** to set the parameters again if required.

----**End**

## 4.1.7 Thermal Settings

### 4.1.7.1 Temperature Parameters

Temperature parameters include: temperature unit, ambient type, ambient temperature, cavity temperature, correctional coefficient and area temperature display mode.

#### Operation Procedure

Step 1 Choose **Configuration >Thermal >Temperature Parameters**.

The **Temperature Parameters** page is displayed, as shown in Figure 4-8.

Figure 4-8 Temperature Parameters interface

**Temperature Parameters**

Open Temperature Measure	<input type="checkbox"/>
Temperature Unit	Celsius
Ambient Temperature	25.00
Cavity Temperature	40.76
Correction Coefficient	0.00
Area Temperature Display Mode	Low Left
Font Border	<input type="checkbox"/>
Custom Colors	<input type="checkbox"/>
Font Color	<span style="background-color: red; color: red;">████████████████████</span>
Area Temperature Type	Highest Temperature
Measure Mode	Preset
Display Alarm Area	<input type="checkbox"/>
Area Alarm Interval(1-1800S)	10
Temperature Range	-40.0 ~ 150.0

Step 2 Set the parameters according to Table 4-3.

Table 4-3 Temperature parameters

Parameter	Description	Setting
Temperature Unit	Celsius and Fahrenheit temperature units are available.	[Setting method] Select a value from the drop-down list box. [Default value] Celsius
Ambient Temperature	The ambient temperature of camera. It is set when ambient is outside.	[Setting method] Enter a value manually.
Cavity Temperature	The cavity temperature of camera.	N/A
Correction Coefficient	Correction coefficient is refer to the deviation of measured object temperature and actual temperature. For example: 1. The measured object temperature is 30, and actual temperature is 37, so the correction coefficient should be <b>7</b> . 2. The measured object temperature is 37, and actual temperature is 30, so the correction coefficient should be <b>-7</b> .	[Setting method] Enter a value manually. [Default value] 0.00
Area Temperature Display Mode	The display position of temperature information on the live-video image.	[Setting method] Select a value from the drop-down list box. [Default value] Low left
Font Border	The font will be bolded.	[Setting method] Enable or disable [Default value] disable
Custom Colors	Enable to custom the color, there are nine colors chosen.	[Setting method] Enable or disable [Default value] disable

Parameter	Description	Setting
Area Temperature Type	There are three types of area temperature.	[Setting method] Select a value from the drop-down list box. [Default value] Highest Temperature
Measure Mode	There are two types measure modes.	[Setting method] Select a value from the drop-down list box. [Default value] General
Display Alarm Area	N/A	[Setting method] Enable or disable [Default value] disable
Area Alarm Interval	N/A	[Setting method] Enter a value manually ranges from 1 to 1800. [Default value] 10

Figure 4-9 Advanced parameter

The screenshot shows a configuration window with a title bar 'Advanced'. It contains the following parameters and their values:

- Dimming Mode: Auto
- Greater Prominent: ON
- Temperature: 0.0
- Color: [Black]
- Section Prominent: ON
- Minimum Temperature: 0.0
- Maximum Temperature: 0.0
- Color: [Black]
- Less Prominent: ON
- Temperature: 0.0
- Color: [Black]
- Raw Data Upload Interval(F/S): 1
- Mix Stream Mode: Close

Buttons for 'Refresh' and 'Apply' are located at the bottom right of the configuration area.

Table 4-4 Advanced parameters

Parameter	Description	Setting
Dimming Mode	There are auto and manual modes. It will show on temperature item.	[Setting method] Select a value from the drop-down list box. [Default value] <b>Auto</b>
Greater Prominent	Enable that, the image will show the setting color if the temperature is higher than set value.	[Setting method] Enter a value manually. Choose one color to show.
Section Prominent	Enable that, the image will show the setting color if the temperature is between minimum and maximum temperature.	[Setting method] Enter a value manually. Choose one color to show.
Less Prominent	Enable that, the image will show the setting color if the temperature is lower than set value.	[Setting method] Enter a value manually. Choose one color to show.

Parameter	Description	Setting
Raw Data Upload Interval(F/S)	Interval of Upload the raw data.	[Setting method] Select a value from the drop-down list box. [Default value] <b>1</b>
Mix Stream Mode	This function is used for thermal and visible lighting image to mix. There are close, mode 1 and mode 2.	[Default value] <b>Close</b>

Step 3 Click **Apply**.

The message "Apply success" is displayed, the system saves the settings.

**----End**

#### 4.1.7.2 Temperature Area

Operation Procedure

Step 1 Choose **Configuration >Thermal >Temperature Area**.

The **Temperature Area** page is displayed, as shown in Figure 4-10

Figure 4-10 Temperature area and alarm configuration

**Temperature Area And Alarm Configuration**

Channel: 1

Measure Mode: Preset

2019-06-19 12:52:09 Wed

Enable	ID	Name	Type	Alarm Type	Warning Value	Alarm Value	Maximum Alarm Value	Emission Rate
<input checked="" type="checkbox"/>	0	Area0	Rectangle	Threshold Alarm	48.00	50.00	60.00	0.95
<input checked="" type="checkbox"/>	1	Area1	Line	Threshold Alarm	48.00	50.00	60.00	0.95
<input checked="" type="checkbox"/>	2	Area2	Polygon	Threshold Alarm	48.00	50.00	60.00	0.95
<input type="checkbox"/>	3	Area3	Point	Threshold Alarm	48.00	50.00	60.00	0.95
<input type="checkbox"/>	4	Area4	Point	Threshold Alarm	48.00	50.00	60.00	0.95
<input type="checkbox"/>	5	Area5	Point	Threshold Alarm	48.00	50.00	60.00	0.95
<input type="checkbox"/>	6	Area6	Point	Threshold Alarm	48.00	50.00	60.00	0.95
<input type="checkbox"/>	7	Area7	Point	Threshold Alarm	48.00	50.00	60.00	0.95

Refresh Apply

Step 2 Set the parameters according to Table 4-5

Table 4-5 Temperature area and alarm configuration

Parameter	Description	Setting
Channel	N/A	[Setting method] Select a value from the drop-down list box. [Default value] <b>1</b>
Measure Mode	Set at temperature parameter interface.	N/A
Enable	Tick to enable the areas	N/A

Parameter	Description	Setting
ID	It ranges from 0 to 19	N/A
Name	Area name of temperature area.	[Setting method] Enter a value manually.
Type	Type of temperature area. ID 0 is default rectangle area, which is full screen.	[Setting method] Select a value from the drop-down list box. [Default value] <b>Rectangle/Point</b>
Alarm Type	Threshold alarm, Section Alarm and Temperature difference alarm are available for alarm type. Section Alarm: if the temperature value is among the set temperature range, it will generate the alarm.	[Setting method] Select a value from the drop-down list box. [Default value] <b>Threshold alarm</b>
Warning Value	Camera will warn when the surveillance object temperature reaches the warning value. At threshold alarm type and difference alarm type can be set.	[Setting method] Enter a value manually. [Default value] <b>48.00</b>
Alarm Value	Camera will alarm when the surveillance object temperature reaches the alarm value.	[Setting method] Enter a value manually. [Default value] <b>50.00</b>
Maximum Alarm Value	At section alarm type, the device would not alarm when the temperature is higher than maximum alarm value.	[Setting method] Enter a value manually. [Default value] <b>60.00</b>
Emission Rate	The emission rate is the capability of an object to emit or absorb energy. The emission rate should be set only when the target is special material. The emission rate list refers to A Common Emission Rate	[Setting method] Enter a value manually. [Default value] <b>0.95</b>



Parameter	Description	Setting
Distance(M)	The distance between camera and target.	[Setting method] Enter a value manually. [Default value] <b>15</b>  <b>NOTE</b> Enter actual distance when the distance between camera and target is less than 15 m. Enter 15 when the distance between camera and target is great than or equal to 15 m.
Alarm	Open or close the alarm output and linkage of area.	[Setting method] Tick the alarm areas

**Step 3 Set temperature area.**

1. Tick an area ID.
2. Select type from drop-list.
3. Press and hold the left mouse button, and drag in the video area to draw a temperature area, as shown in Figure 4-11. Right-click to finish the area selected.

Figure 4-11 Temperature Area Setting Interface

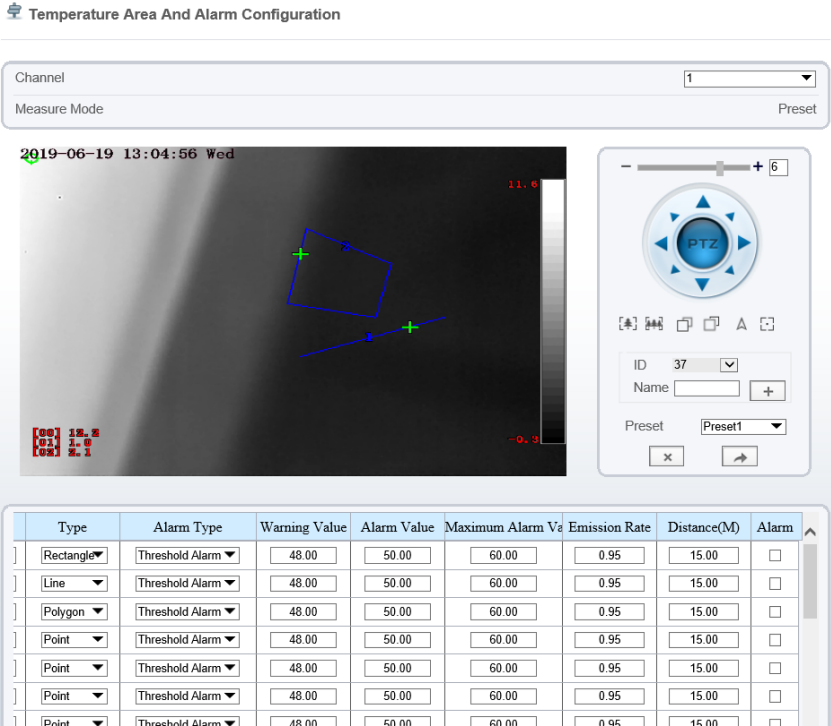

4. Click **Apply**, the message “Apply success” is displayed, the temperature area is set successfully.

**Delete a temperature area:**

1. Select an area ID.
2. Click the temperature area and right-click.
3. Remove the tick of area ID.
4. Click **Apply**, the message “Apply success” is displayed, the temperature area is deleted successfully.

Step 4 Click **Apply**.

The message "Apply success" is displayed, the system saves the settings.

----End

### 4.1.7.3 Schedule Linkage

#### Operation Procedure

Step 1 Choose **Configuration > Thermal > Schedule Linkage**

The **Schedule Linkage** page is displayed, as shown in Figure 4-12.

Figure 4-12 Schedule Linkage

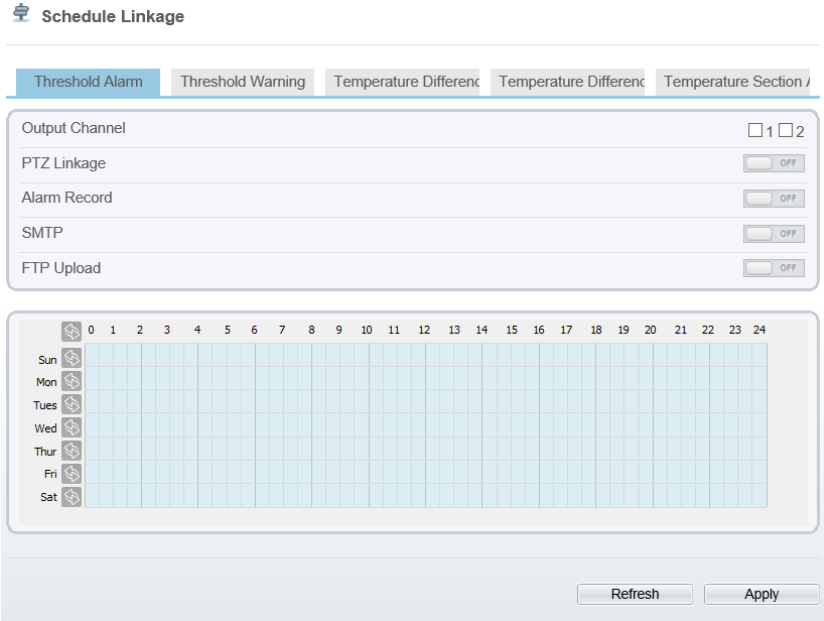

Step 2 Tick the output channel.

Step 3 Enable “PTZ Linkage”, “Alarm Record”, “SMTP”, “FTP” button.

Step 4 Set schedule linkage.

**Method 1:** Click left mouse button to select any time point within 0:00-24:00 from Monday to Sunday as shown in Figure 4-12.

**Method 2:** Hold down the left mouse button, drag and release mouse to select the alarm time within 0:00-24:00 from Sunday to Saturday.

 **NOTE**

When you select time by dragging the cursor, the cursor cannot be moved out of the time area. Otherwise, no time can be selected.

**Method 3:** Click  in the alarm time page to select the whole day or whole week.

**Deleting alarm time:** Click  again or inverse selection to delete the selected alarm time.

Step 5 Click **Apply**.

The message "Apply success" is displayed, the system saves the settings.

----End

### 4.1.7.4 Bad Point Check

#### Description

The points that can't move when the environment or scenario change is bad point. You can delete the bad point by bad point check function.

#### Procedure

Step 1 Choose **Configuration > Thermal > Bad Point Check**

The **Bad Point Check** page is displayed, as shown in Figure 4-13.

Figure 4-13 Bad Point Check



Step 2 Click the white point at image, click **Apply** to recover the bad point, as shown in Figure 4-14

Figure 4-14 Recover bad point



Step 3 Click **Reset** to return the previous settings.

Step 4 Click **Apply**. The message "Apply success" is displayed, the system saves the settings.

----End

# 5 Thermal Parameter Configuration

## 5.1 Access the Sensor Setting Interface

Operation procedure:

- Step 1 On the web interface or client interface, move the cursor to the real-time video page and right-click on the page. A shortcut menu is displayed, as shown in Figure 5-1, and Table 5-1 describes the sensor setting interface.

Figure 5-1 Sensor Setting interface

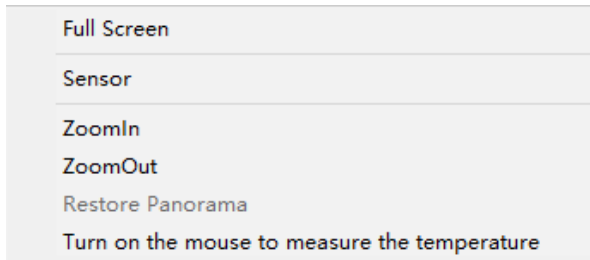

Table 5-1 Sensor Setting interface

Parameter	Description
Full Screen	It enlarges and displays the image in full screen.
Sensor Configure	It is used for configuring the parameter set of front-end images.
Zoom In/Out	It zooms in/out images by electronic means. This function may also be used with the mouse wheel.
Open point measurement (Turn on the mouse to measure the temperature)	Click this option to measure the target temperature that the mouse moved.

- Step 2 Choose **Sensor Configure** and the **Sensor Setting** dialog box appears.

----End

## 5.2 Sensor Setting Parameter

### 5.2.1 Time Segment

Operation procedure:

- Step 1 Click **Time** Segment tag on sensor setting interface, the time segment page is displayed, as shown in Figure 5-2.

Figure 5-2 Time Segment page

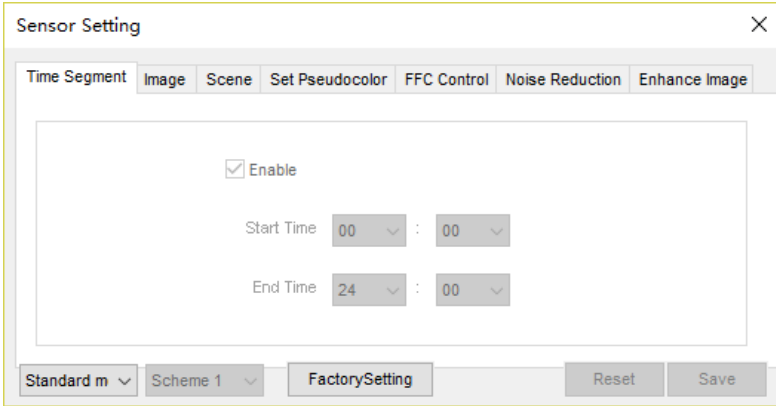

- Step 2 Choose Debug Model in the lower left corner to activate the sensor setting page.
- Step 3 Set the time segment parameters.
- Step 4 Click save to save the setting.

----End

### 5.2.2 Image Setting

Figure 5-3 shows the image setting interface.

Figure 5-3 Image setting interface

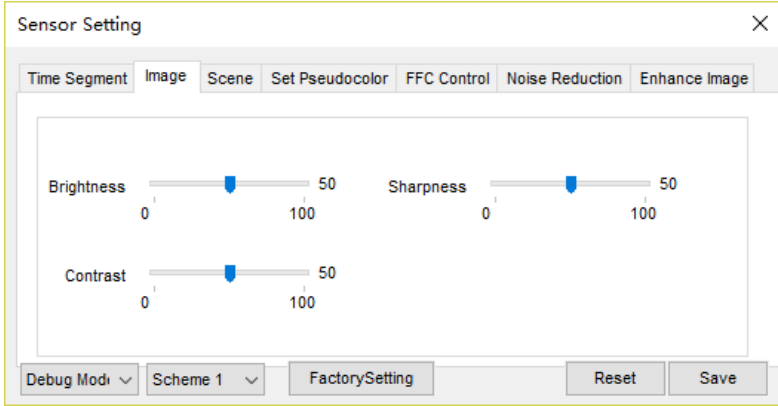

Table 5-2 describes the image setting parameters.

Table 5-2 Image setting parameter description

Parameter	Description	Setting
Brightness	It indicates the total brightness of an image. As the value increases, the image becomes brighter.	[Setting method] Drag the slider. [Default value] <b>50</b>
Contrast	It indicates the contrast between the bright part and the dark part of an image. As the value increases, the contrast increases.	[Setting method] Drag the slider. [Default value] <b>50</b>
Sharpness	It indicates the sharpness of the image plane and the sharpness of the image edge. The shaper the image, the better detail contrast.	[Setting method] Drag the slider. [Default value] <b>50</b>

----End



### 5.2.3 Scene

Figure 5-4 shows the scene interface.

Figure 5-4 Scene interface

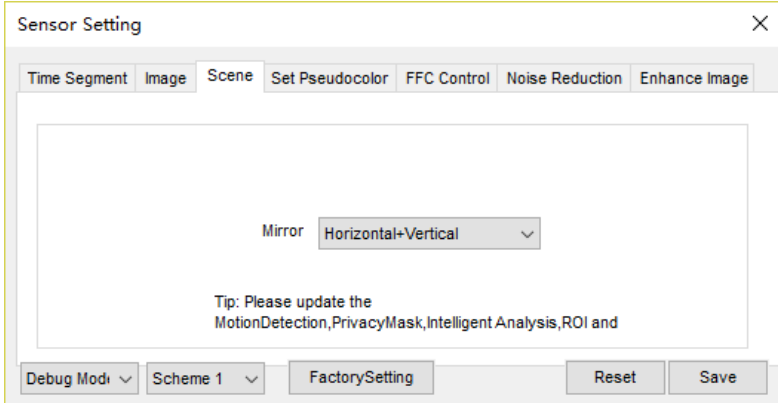

Provide the selection of image pixel locations.

Normal: the image is not flipped.

Horizontal: the image is flipped left and right.

Vertical: the image is flipped up and down.

Horizontal + Vertical: the image upside-down and reversal.

### 5.2.4 Set Pseudocolor

Figure 5-5 shows the set pseudocolor interface.

Figure 5-5 set pseudocolor interface

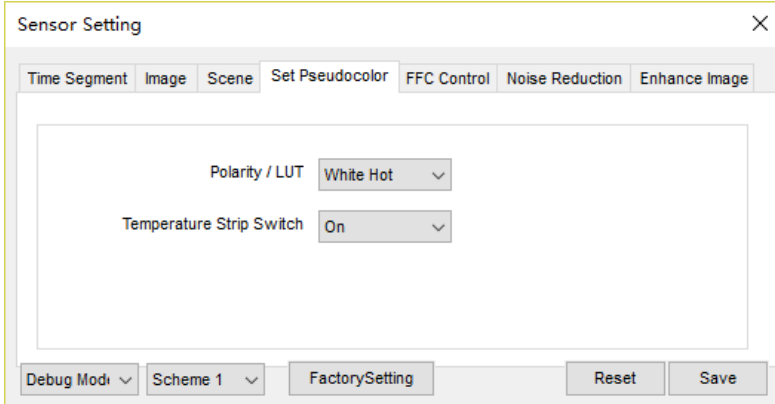

Polarity/LUT: the temperatures of the temperature fields detected by the thermal imaging camera are separately mapped to values ranging from 0 to 255 by the algorithm. In the black/white display mode, this range is converted to the grayscale tones. For example, 0 indicates completely black, and 255 indicates completely white. The temperature field of the scene is converted to images by using the grayscale ranging from 0 to 255. Different polarity modes can be converted to different display images. The most common setting is white hot (a hotter object is displayed brighter than a colder object) or black hot (a hotter object is displayed darker than a colder object). The difference between two modes lies in that the temperatures corresponding to the darker one and the lighter one are reversed. Other modes include rainbow, ironbow, HSV, autumn, bone and so on.

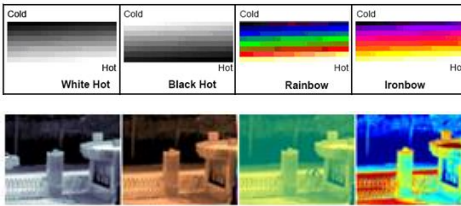

**Temperature strip switch** is on, the live video will show it, otherwise is no strip.

### 5.2.5 FFC Control

Figure 5-6 shows the FFC mode interface.

Figure 5-6 FFC mode interface

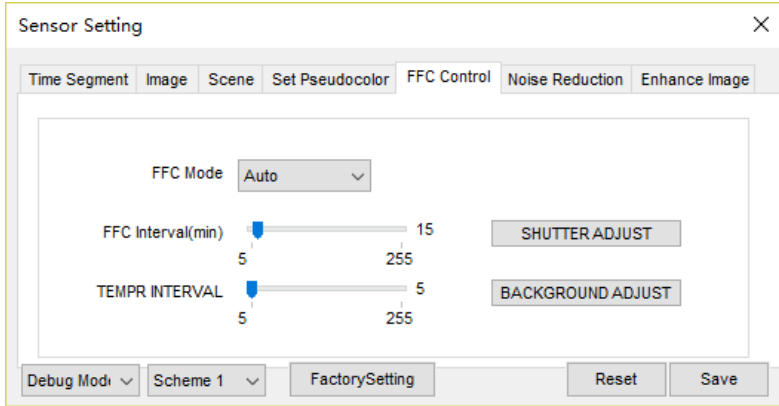

Table 5-3 describes the FFC mode parameters.

Table 5-3 FFC control parameter description

Parameter	Description	Setting
FFC Mode	<p>The internal of the thermal imaging camera may comprise the mechanical action correction mechanism that can periodically improve the image quality. This component is called flat field correction (FFC). When controlling the FFC, the FFC shields the sensor array, so that each portion of the sensor can collect uniform temperature fields (flat field). By means of FFC, the camera can update the correction coefficients to output more uniform images. Throughout the FFC process, the video image is frozen for two seconds and a static-frame image is displayed. After the FFC is complete, the image is automatically recovered. Repeated FFC operations can prevent the grainy and image degradation problems. The FFC is especially important when the temperature of the camera changes. For example, after the camera is powered on or the ambient temperature is changed, you should immediately perform the FFC.</p> <p><b>Auto:</b> In the Automatic FFC mode, the camera performs FFC whenever its temperature changes by a specified amount or at the end of a specified period of time (whichever comes first). When this mode is selected, the FFC interval (minutes) ranges from 5 to 30 minutes. The temperature</p>	<p>[How to set] Select from the drop-down list box. [Default value] <b>Auto</b></p>

Parameter	Description	Setting
	<p>change of the camera is based on the temperatures collected by the internal temperature probe. The temperature of the camera sharply changes when the camera is powered on. The FFC is relatively frequent, which is normal.</p> <p><b>Manual:</b> In the manual FFC mode, the camera does not automatically perform the FFC based on the temperature change or the specified period. You can press the Do FFC button to select the manual FFC mode. When you feel that the image is obviously degraded but the automatic FFC is not performed, you can use the manual FFC function to check whether the image quality can be improved.</p>	
FFC Interval (min)	In the automatic FFC mode, the FFC interval ranges from 5 to 255 minutes.	[How to set] Drag the slider. [Default value] <b>5</b>
Temper Interval	In the automatic FFC mode, the FFC interval ranges from 5 to 25.5 centigrade.	[How to set] Drag the slider. [Default value] <b>5</b>
Shutter Adjust	Click the icon to adjust exposure immediately.	N/A
Background Adjust	Click the icon and cover the camera with something to adjust image. Remove the thing to finish adjustment.	N/A

----End

## 5.2.6 Noise Reduction

Figure 5-7 shows the Noise reduction interface.

Figure 5-7 Noise reduction interface

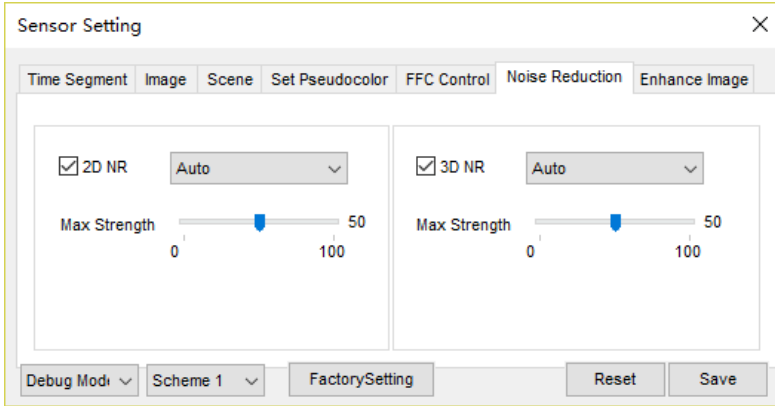

Table 5-4 describes noise reduction parameters.

Table 5-4 DNR parameter description

Parameter	Description	Setting
2 DNR	Decrease the image noise.	[How to set] Select from the drop-down list box. Drag the slider to adjust max strength. [Default value] <b>Auto</b>
3 DNR	Decrease the image noise.	[How to set] Select from the drop-down list box. Drag the slider to adjust max strength. [Default value] <b>Auto</b>

----End

### 5.2.7 Enhance Image

Figure 5-8 shows the screen adjustment interface.

Figure 5-8 Enhance image interface

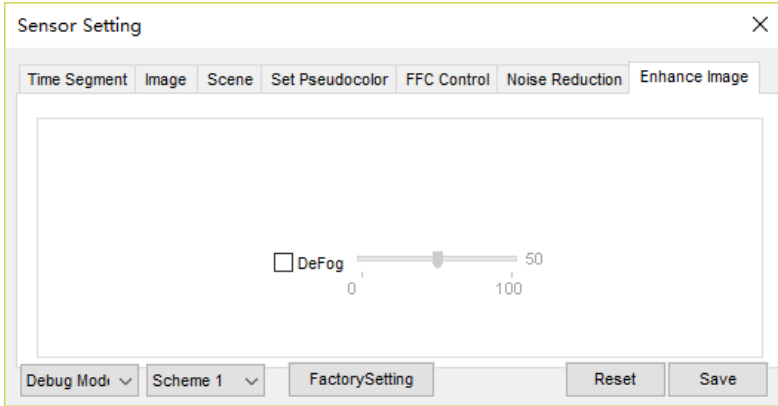

Drag the slider to adjust. The default value is 50.

----End

# 6 PTZ Function Application

## 6.1 PTZ Control function

### Operation Description

PTZ Control function is only available to a camera with an external PTZ and High Speed Dome with PTZ function.

### PTZ Control

When browsing real-time videos shot by a dome camera or a camera connected to an external PTZ, you can control the PTZ to view Video shot in different directions.



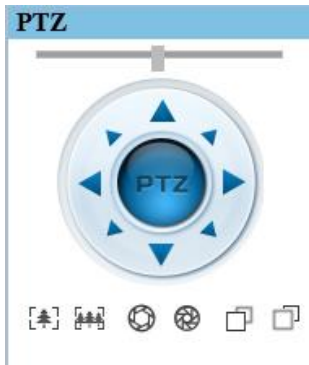

In the PTZ control area, you can click the eight arrow keys to move the PTZ in eight directions, as shown in Figure 6-1.



Figure 6-1 PTZ Control zone



It may also control the iris, zoom and focus of the camera lens through other buttons in the PTZ control zone. Functions of each button are as shown in Table 6-1.

Table 6-1 Descriptions of PTZ buttons

Button	Description
Auto Zoom	Click  or  to adjust the surveillance range of the front-end lens.
Auto Iris	Click  or  to adjust the size of the front-end iris.

Auto Focus	Click  or  to adjust the focus of the front-end lens.
Speed	Drag the slider on  to adjust the rotational speed of the PTZ.

----End

## 6.2 PTZ configuration

### 6.2.1 PTZ Setting

Click , the PTZ configuration interface displayed, as shown in Figure 6-2.

Figure 6-2 PTZ Configuration



Through this interface, you can perform the following operations:

- Add, Delete and Apply a Preset, Track, Scan and Tour.
- Set and enable Idle.
- Set the direction to due north.
- Any direction can be set as the reference due north.
- Configure Timer.

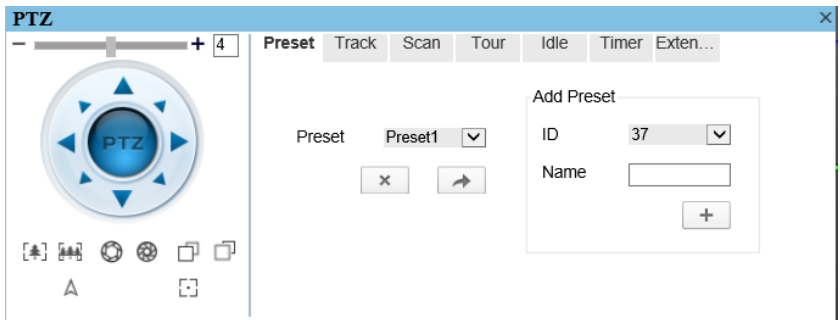
----End

### 6.2.2 Configure and Apply Preset

You can configure preset positions and quickly rotate the camera to preset position by applying the preset.



### Operation procedure

Step 1 Click **Preset** tab page in the PTZ configuration interface, the add preset page is displayed, as shown in Figure 6-3.

Figure 6-3 Add Preset

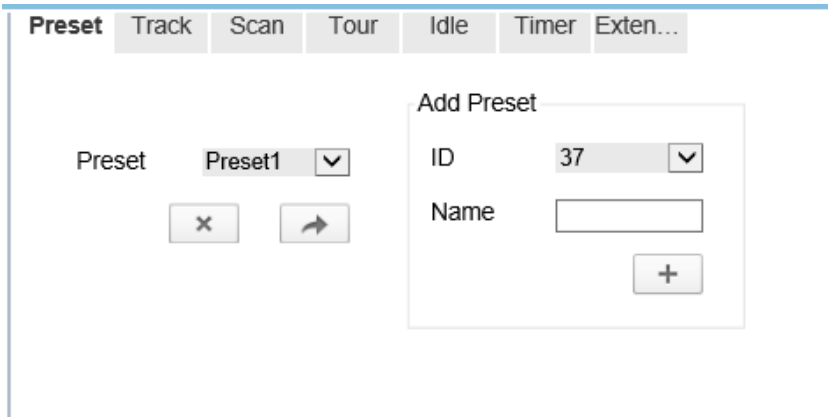

Step 2 Select a preset ID (such as 1) from the Preset drop-down list box and enter the name of preset.

Step 3 Use eight arrow keys in the **PTZ control** area to configure a position, then click **+** to complete adding a preset.

Step 4 Select a Preset name from the Preset drop-down list box and click **→** to apply the preset.

 **NOTE**

Up to 400 Presets can be configured

**----End**

## 6.2.3 Configure and Apply Tracks



You can record a track to allow the camera to repeatedly rotate based on the preset track.

### Operation procedure

Step 1 Click **Track** tab page in the PTZ configuration interface, the add track page is displayed as shown in Figure 6-4.

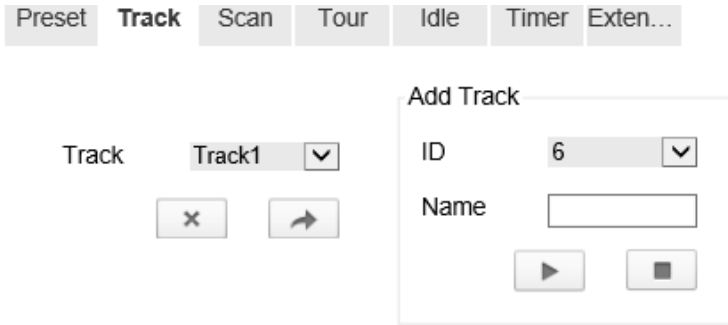
Figure 6-4 Add Track



- Step 2 Select a track ID (such as 1) from the track drop-down list box and enter the name of track.
- Step 3 Click , then use eight arrow keys in the **PTZ control** area to configure a track, then click  to complete adding a track.
- Step 4 Select a Track name from the Track t drop-down list box and click  to apply the track.

 **NOTE**

Up to 6 Tracks can be configured.

----End

## 6.2.4 Configure and Apply Scan



You can configure a Scan to rotate the camera between two positions by applying the Scan.

### Operation procedure

- Step 1 Click **Scan** tab page in the PTZ configuration interface, the add Scan page is displayed, as shown in Figure 6-5.

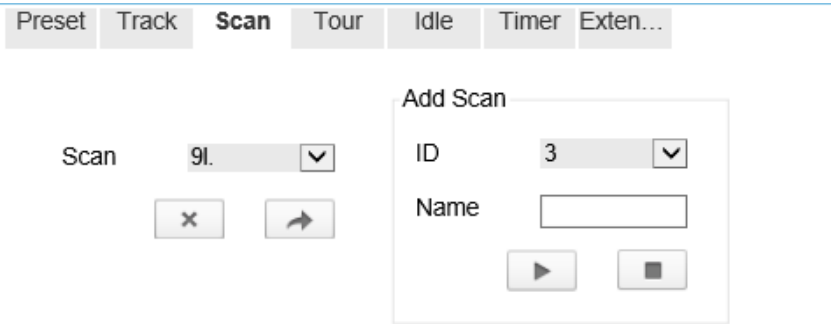
Figure 6-5 Add Scan



- Step 2 Select Scan ID (such as 1) from the track drop-down list box and enter the name of scan.
  - Step 3 Click , then use eight arrow keys in the **PTZ control** area to configure two positions, then click  to complete adding a scan.
  - Step 4 Select a Scan name from the Scan t drop-down list box and click  to apply the scan.
- End

## 6.2.5 Configure and Apply Tour

You can configure a tour to rotate the camera between presets set by PTZ.

### Operation procedure





- Step 1 Click **Tour** tab page in the PTZ configuration interface, the add tour page is displayed, as shown in Figure 6-6.

Figure 6-6 Add Tour

The screenshot shows the PTZ configuration interface with the 'Tour' tab selected. The main configuration area includes:

- Tour ID:** A drop-down menu showing '3'.
- Name:** An empty text input field.
- Preset:** A drop-down menu showing 'Preset1'.
- Wait Time:** A text input field showing '0'.

Below these fields are four buttons: a close button (X), a right arrow button, a pause button (||), and a play button (▶). To the right, there is an 'Add Tour' dialog box with its own fields for ID (3), Name, Preset (Preset1), and Wait Time (0), along with a checkmark button and play/stop buttons.

- Step 2 Select Tour ID (such as 2) from the drop-down list box, enter the tour name.
- Step 3 Select first required position preset from the **Preset** drop-down list box.
- Step 4 Input the values from **Wait Time** area box to set the time to stay in this position preset.(0 sec~ 255 sec).
- Step 5 Click  button to begin setting tour.
- Step 6 Select next position preset form the preset drop-down list box, and then input the values from Wait Time area box to set the time to stay in next position preset.(0 sec~ 255 sec).
- Step 7 Click  to add the preset to tour.
- Step 8 Repeat former step until all required position presets are completed adding.
- Step 9 Click  to complete adding a tour (You also can click Cancel button to quit current setting).
- Step 10 Select a tour name and preset from the tour and preset drop-down list box, and then click  to apply the tour.

----End

## 6.2.6 Configure and Apply Idle

You can configure an idle to `apply preset. Scan, Track, or Tour regularly.



### Operation procedure

- Step 1 Click **Idle** tab page in the PTZ configuration interface, the idle page is displayed, as shown in Figure 6-7.

Figure 6-7 Idle

The screenshot shows the PTZ configuration interface with the 'Idle' tab selected. The interface includes the following elements:

- Tabs: Preset, Track, Scan, Tour, **Idle**, Timer, Exten...
- Enable: ON (toggle switch)
- Type: Preset (dropdown menu)
- Name: Preset1 (dropdown menu)
- Wait Time: 1 (input field)
- Checkmark button (confirm)

- Step 2 Select a monitor type from the **Type** drop-down list box. Monitor type can choose preset, Scan, track, tour and Cir Scan.
  - Step 3 Select a name form the **Name** drop-down list box.
  - Step 4 Input a value from the **Wait Time** area box.
  - Step 5 Click  to completed adding an idle.
  - Step 6 Click  to enable idle function.
- End

## 6.2.7 Configure Timer

### Operation procedure

- Step 1 Click **Timer** tab page in the PTZ configuration interface, the set timer page is displayed, as shown in Figure 6-8.

Figure 6-8 Set Timer

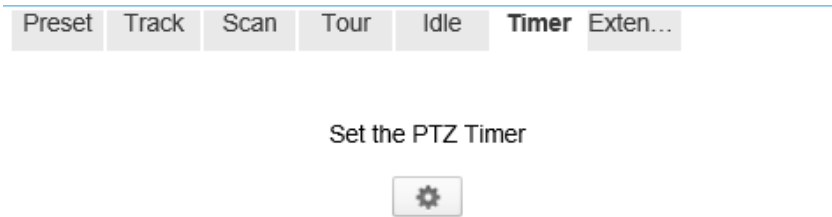

Step 2 Click , the Timer page is displayed, as shown in Figure 6-9.

Figure 6-9 Timer

Timer	Begin Time	End Time	PTZ Type	Name	Clear
1	▼	▼	▼	▼	×
2	▼	▼	▼	▼	×
3	▼	▼	▼	▼	×

Step 3 Check **Enable** box.

Step 4 Select the timer mode.

Step 5 Select the required begin time at the **Begin Time** drop-down list box, and then select the required end time at the **End Time** drop-down list box.

- Step 6 Select the required monitor type at the PTZ type drop-down list box, you can select preset, Scan, Track, Tour in the box, and then select a specific from the **Name** drop-down list box.(for example preset, 1).
  - Step 7 Repeat Step 5 and Step 6 to add more required time.
  - Step 8 Click  to complete timer setting.
- End

## 6.2.8 Configure Extension

You can use extension function including lamp and brush.

### Operation procedure

- Step 1 Click **Extension** tab page in the PTZ configuration interface, the extension page is displayed, as shown in Figure 6-10.

Figure 6-10 Extension

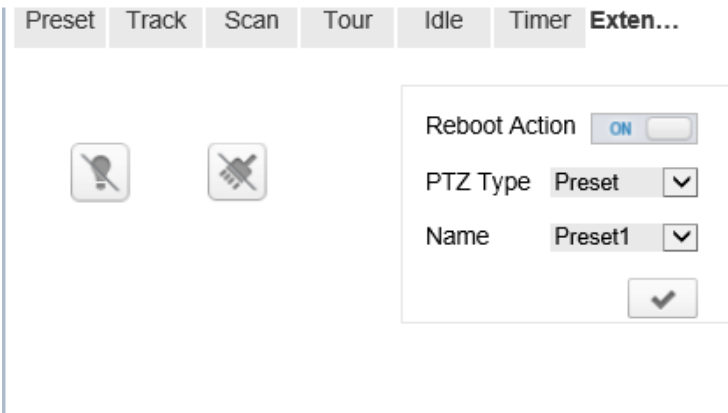

- Step 2 Click  to enable the lamp.

Light On/Off is used to control the infrared camera shields on and off. It's available only to specific camera shields.

- Click  to enable the brush.

Brush is used to clean the lens. It's available only to a camera with a brush or a camera shield.

----End

# 7 Technical Specifications

Table 7-1 describes the technical specifications of Dual Vision Medium-load Thermal PTZ .

Table 7-1 Technical specification

Item	Parameter	Description
Thermal Detector Features	Detector type	Non-cooling IR focal plane sensor
	Material	F_VOx
	Effective Pixel	400*300
	Resolution	704*576
	Pixel Size	17um
	Response Wavelength	8um~14um
	Thermal Sensitivity/NETD	40mK /F1.0
	Frame Frequency	50/60Hz
	Focal Length	8/15/25mm
	Focusing Mode	Manual
	Field Angle	46 ° x 35 ° /25 ° x 19 ° /15 ° x 11 °
	Aperture	1.0
	Recognition Distance (Body)	59m/110m/184m
	Recognition Distance (Vehicle)	180m/338m/564m
	Focal Length	8/25mm
	Focusing Mode	Motorized
	Field Angle	46 ° x 35 ° /15 ° x 11 °
	Aperture	1.0
	Recognition Distance (Body)	59m/184m



Item	Parameter	Description
	Recognition Distance (Vehicle)	180m/564m
	DNR	Auto/Manual, 2D/3D
	Correction	Auto/Manual/External
	Polarity Control/ LUT	White Hot / Black Hot / Rainbow /Ironbow /(Up to 17 define optional)
Visual camera features	Pixel	300W 2048 (H)×1536(V)
	Optical Zoom	30X
	Focal Length	4.6 mm~138mm
	Focus Control	Auto/Manual
	Min. illumination	Color: 0.001Lux @ (F1.2, AGC ON) B/W: 0.0001Lux @ (F1.2, AGC ON)
	Day & Night	ICR, D/N auto switch
	Defog	Support
Temperature features	WDR	More than 120dB
	Temperature Detection	Point detection, Area detection, Full screen detection
	Temperature Alarm	Over temperature alarm, Temperature difference alarm
	Precision	Max (±2°C, ±2%)
	Detection Area	Support
	Response Time	≤30ms
	Temperature Measurement Range	-40°C~+150°C
System functions	Temperature Display Mode	Temperature target >5°C, Display absolute temperature value; Temperature target ≤5°C, Display relative temperature value (temperature difference DEV = highest value - average)
	Intelligent Alarm	Motion Detection Alarm, I/O Alarm, Disk Alarm, Threshold Alarm
	Intelligent Analysis	Perimeter, Single Virtual Fence, Double Virtual Fence, Object Left, Object Removed
	Time-phased Configuration	Support
	Privacy Masking	Support
	Text Overlay	Temperature, Time, Date, Device name and

Item	Parameter	Description
		Custom text.
Encode features	Video Compression Formats	H.265/H.264//MJPEG
	Audio Compression Formats	G.711:8kbps; RAW_PCM:16kbps
	Resolution/Frame	2048x1536/30fps fps(visual) , D1/30fps (thermal)
	Video System	PAL/NTSC
	Multiple Stream	Support
	Stream Control	CBR/VBR
Network features	Network Protocol	IPv4/RTSP/RTP/RTCP/TCP/UDP/HTTP/DHCP/DNS/DDNS/PPPOE/SMTP
	Maximum User Access Amount	Supports up to 10 users simultaneously access
	Security	Password protection, support for multi-level user group management, custom permissions, a reset button
	Integration Features	Support international standards Onvif, GB/T28181 (Support customized)
PAN /TILT Features	Rotating Speed	Pan:0.01 ~30 %s, Tilt:0.01 ~10 %s
	Rotation Angle	Pan:0 ~360 °continuously, Tilt:+90 ~-90 °
	Brush	Support
	Preset Positioning Accuracy	±0.1 °
	Number of Presets	Up to 400
	Scan	8 scans
	Tour	12 Tours
	Pattern	6 Tracks
	Idle	Support
	3D Positioning	Support
	Coordinate Display	Support
	Direction Display	Horizontal/Vertical/Zoom
Angel Return	Pan angle, tilt angle and return	

Item	Parameter	Description
	Speed Control	Support
	Power-off memory	Support
	Reset	Support
Interface features	Network Interface	RJ-45 and 10/100Base-T
	Alarm Interface	1 output
	CVBS Interface	Support
	Pan & Tilt Control Interface	RS485
	SD Card Connector	Micro SD card, 128 GB to the maximum
physical features	Power Supply	DC24V
	Power Consumption	Max 30W
	Operating Temperature	-30°C ~ +60°C
	Operating Humidity	< 90%RH
	Protection Level	IP66
	Installation Mode	Mounting bracket
	Dimensions	322 x 192 x 163 mm(L x W x H)
	Weight	5Kg

# A Troubleshooting

Common Trouble	Possible Cause	Solution
Unable to access the web	Network is not connected.	<ul style="list-style-type: none"> <li>• Connect the network cable of the camera to the PC to check whether the network cable is in good contact.</li> <li>• Run the ping command to check the network connection and whether the device works normally.</li> </ul>
	IP address is occupied.	Directly connect the camera to the PC, and reset the IP address of the camera.
	The IP addresses of the PC and the device are in different networks.	Check the IP address, subnet mask and gateway setting of the camera.
PTZ or high speed dome is out of control.	The protocol, bit-rate, or address setting of the PTZ is incorrect.	Modify the address of the PTZ on the web.
	The signal cable is unconnected or not connected correctly.	Check the signal strength, and reconnect the signal cable.
The measured temperature is not accurate.	The device is just powered on, and the temperature of the cavity is unstable.	The temperature of the cavity is stable within 15 to 30 min after the device is powered on.
	The FFC mode is incorrect.	The FFC mode is auto by default. If the mode is set to manual, it will be no block calibration, which may lead to fuzzy pictures and inaccurate temperature.
	The target configuration is incorrect.	Check whether the emission rate and distance of the target are configured correctly.

Common Trouble	Possible Cause	Solution
An error occurs in accessing the web of the device after the upgrade.	The data in the cache of browser is not updated in time.	<p>Delete the cache of the Internet Explorer. The steps are as follows (taking IE9 as an example):</p> <ol style="list-style-type: none"> <li>1. Open the Internet Explorer.</li> <li>2. Select <b>Tools &gt; Internet Options</b>.</li> <li>3. On the <b>General</b> tab, select <b>Delete</b> under <b>Browsing history</b>. The <b>Delete Browsing History</b> dialog box appears.</li> <li>4. Select all check boxes.</li> <li>5. Click <b>Delete</b>.</li> </ol> <p>Relogin the web page of the camera.</p>
Upgrade failed.	No network cable is connected.	Ensure the upgrade network is connected.
	The network setting is incorrect.	Check whether the network setting is correct.
	The upgrade package is incorrect.	Perform the correct upgrade package again.
No self-test no image output	There is a broken line in the circuit	Find breakpoints, rewiring.
	Low supply voltage	Replace the power adapter to increase the output voltage.
Self-test exception	Low supply voltage	Replace the power adapter to increase the output voltage.
Equipment control is normal, image instability (Analog video)	Poor video circuit contact	Troubleshooting, rewiring
	Access device exception	Replacement access device
Equipment control is normal, image instability (Web video)	Network line bad contact	Dismantling bad point, re-wiring.
	Access to computer performance is insufficient, take up CPU usage	Lower stream and resolution

Common Trouble	Possible Cause	Solution
	Lack of network bandwidth	Replacement of industrial Gigabit switches
	Access decoder performance decoder	Replacement of high-performance decoder
Self-test normal, can not control	Wrong wiring	Rewiring
	Set the baud rate, protocol, address and device mismatch	Screen configuration according to device parameters
Repeated restart	Insufficient supply voltage or voltage instability	To ensure that the input device voltage stability
Can not control the lens to perform zoom and Focus action	Wiring error	Re-connect the lens control line
	Circuit board lens control problems	Replacement circuit board (please contact after-sales rework processing, do not replace parts or repair)
Can not recall the set lens preset point	DIP switch relative to the set lens preset dialing is not set to ON	DIP switch control lens preset dialing dial into ON
The image is lost when the control device rotates	Rotation process at the same location lost image	Conductive slip ring there is a bad contact, replace the parts (please contact after-sales rework, do not replace parts or repair)

# B Common Emission Rate

## Emission Rate

The emission rate is the capability of an object to emit or absorb energy. An ideal transmitter provides an emission rate of emitting 100% of intake energy. An object with an emission rate of 0.8 can absorb 80% of intake energy, and reflect the remaining 20%. The emission rate is the ratio of the energy emitted by an object at a specific temperature to that emitted by an ideal radiator at the same temperature. The range of emission rate value is 0.0 to 1.0 generally.

Materials	Temperature (°C/°F)	Emissivity
Gold (High-purity)	227/400	0.02
Aluminum foil	27/81	0.04
Aluminum sheet	27/81	0.18
Aluminum used for families (flat)	23/73	0.01
Aluminum plate (98.3% purity)	227/440	0.04
	577/1070	0.06
Aluminum plate (rough)	26/78	0.06
Aluminum (oxidized @ 599°C)	199/390	0.11
	599/1110	0.19
Polished aluminum	38/100	0.22
Tin (light tinned Iron sheet)	25/77	0.04
Nickel wire	187/368	0.1

Lead (99.9% purity, No oxidized)	127/260	0.06
Copper	199/390	0.18
Cobalt	599/1110	0.19
Steel	199/390	0.52
	599/1110	0.57
Tinned iron sheet (Light)	28/82	0.23
Brass(High-polish)	247/476	0.03
Brass (Tough rolled, polished metal wire)	21/70	0.04
Tinned Iron (Light)	-	0.13
Iron plate (Rust eaten)	20/68	0.69
Rolled steel sheet	21/71	0.66
Ferric oxide	100/212	0.74
Wrought-iron	21/70	0.94
Fused iron	1299-1399/3270-2550	0.29
Copper (Polished)	21-117/70-242	0.02
Copper(Polished, not reflected)	22/72	0.07
Copper (Heavy oxide Board )	25/77	0.78
Enamel (Fuse on iron)	19/66	0.9
Formica Plate	27/81	0.94
Frozen soil	-	0.93



Brick (Red, rough)	21/70	0.93
Brick (Unglazed, rough)	1000/1832	0.8
Carbon (T - carbon 0.9% ash)	127/260	0.81
Concrete	-	0.94
Glass (Glossy)	22/72	0.94
Granite (Surfaced)	21/70	0.85
Ice	0/32	0.97
Marble (I Polished, grey)	22/72	0.93
Asbestos board	23/74	0.96
Asbestos paper	38/100	0.93
	371/700	0.95
Asphalt ( Paving the road)	4/39	0.97
Paper ( Black tar)	-	0.93
Paper (White)	-	0.95
Plastic (White)	-	0.91

101-500-0248-01